

G.B.N. GOVERNMENT POLYTECHNIC, NILOKHERI

BRANCH: MECHANICAL ENGINEERING

SUBJECT: MACHINE DESIGN

SEMESTER: 5th

CONTENTS

1 INTRODUCTION

- 1.1 Design – Definition, Type of design, necessity of design
 - 1.1.1 Comparison of designed and Undersigned work,
 - 1.1.2 Design Procedure
 - 1.1.3 Characteristics of a good designer
- 1.2 Design terminology: stress, strain, factor of safety, factors affecting factor of safety, stress concentration, methods to reduce stress concentration, fatigue, endurance limit.
 - 1.2.1 General design consideration
 - 1.2.2 Codes and Standards (BIS standards)
- 1.3 Engineering materials and their properties
 - 1.3.1 Properties of engineering materials: elasticity, plasticity, malleability, ductility, toughness, hardness and resilience. Fatigue, creep, tenacity and strength etc.
 - 1.3.2 Selection of materials, criteria of material selection

2 DESIGN FAILURE

- 2.1 Various design failures-maximum stress theory, maximum strain theory
- 2.2 Classification of loads
- 2.3 Design under tensile, compressive and torsional loads

3 DESIGN OF SHAFT

- 3.1 Type of shaft, shaft materials, Type of loading on shaft, standard sizes of shaft available
- 3.2 Shaft subjected to torsion only, determination of shaft diameter (hollow and solid shaft) on the basis of : - Strength criterion,

Rigidity criterion

- 3.3 Determination of shaft diameter (hollow and solid shaft) subjected to bending
- 3.4 Determination of shaft diameter (hollow and solid shaft) subjected to combined torsion and bending.

4. DESIGN OF KEY

- 4.1 Types of key, materials of key, functions of key
- 4.2 Failure of key (by Shearing and Crushing).
- 4.3 Design of key (Determination of key dimension)
- 4.4 Effect of keyway on shaft strength

CHAPTER-1

INTRODUCTION

1.1 DESIGN – DEFINITION

Design is defined as the use of imagination, scientific principles and engineering techniques to create a part or structure economically, in order to satisfy the requirements of a customer. Machine design is the first step involved in creation of a machine. It gives the basic idea of how a machine will look and function.

1.1 DESIGN - TYPES OF DESIGN

The design may be classified as follows:

- 1. Adaptive design.** In most cases, the designer's work is concerned with adaptation of existing designs. This type of design needs no special knowledge or skill and can be attempted by designers of ordinary technical training. The designer only makes minor alternation or modification in the existing designs of the product.
- 2. Development design.** This type of design needs considerable scientific training and design ability in order to modify the existing designs into a new idea by adopting a new material or different method of manufacture. In this case, though the designer starts from the existing design, but the final product may differ quite markedly from the original product.
- 3. New design.** This type of design needs lot of research, technical ability and creative thinking. Only those designers who have personal qualities of a sufficiently high order can take up the work of a new design.

The designs, depending upon the methods used, may be classified as follows:

- (a) Rational design.** This type of design depends upon mathematical formulae of principle of mechanics.

(b) **Empirical design.** This type of design depends upon empirical formulae based on the practice and past experience.

(c) **Industrial design.** This type of design depends upon the production aspects to manufacture any machine component in the industry.

(d) **Optimum design.** It is the best design for the given objective function under the specified constraints. It may be achieved by minimizing the undesirable effects.

(e) **System design.** It is the design of any complex mechanical system like a motor car.

(f) **Element design.** It is the design of any element of the mechanical system like piston, crankshaft, connecting rod, etc.

(g) **Computer aided design.** This type of design depends upon the use of computer systems to assist in the creation, modification, analysis and optimization of a design.

DESIGN - NECESSITY OF DESIGN

1. To convert existing old design into new designs.
2. To encourage the market with new ideas and technologies inserted in new designs.
3. To create new and better machines.
4. For faster production.
5. For automation of industries.
6. For better quality and to control the cost of products.
7. For innovation of new products.

COMPARISON OF DESIGNED AND UNDESIGNED WORK

	Designed Work	Undesigned Work
1.	It is cost controlled.	There is no control on the cost.
2.	It is quality controlled.	There is no control on the quality of the product.
3.	Product gives good appearance.	Product does not give good appearance.
4.	More costly.	Less costly.
5.	More output.	Less output.
6.	More efficient.	Less efficient.
7.	The strength of product is more.	The strength of the product is less.
8.	It is more reliable.	It is less reliable.
9.	It is more durable since it is made by inserting right dimensions.	It is less durable being undesigned.
10.	It has appropriate dimensions and its outlook is good.	It does not have appropriate dimensions and hence it is of poor quality.
11.	Research and development work is easier to conduct.	Research and development work cannot be conducted.

DESIGN PROCEDURE

In designing a machine component, there is no rigid rule. The problem may be attempted in several ways. However, the general procedure to solve a design problem is as follows:

- 1. Recognition of need.** First of all, make a complete statement of the problem, indicating the need, aim or purpose for which the machine is to be designed.
- 2. Synthesis (Mechanisms).** Select the will give the desired motion.
- 3. Analysis of forces.** Find the forces acting on each member of the machine and the energy transmitted by each member.



4. Material selection. Select the material best suited for the each member.

5. Design of elements (Size and Stresses considering the force acting on the member and the permissible stresses for the material used. It should be kept in mind that each member limits.

6. Modification. Modify the size of the member to agree with the past experience and judgment to facilitate manufacture. The modification may also be necessary by consideration of manufacturing to reduce overall cost.

7. Detailed drawing. Draw the detailed drawing of each component and the assembly of the machine with complete specification for the manufacturing processes suggested.

8. Production. The component, as per the drawing, is manufactured in the workshop.

CHARACTERISTICS OF A GOOD DESIGNER

A good designer should possess the following characteristics:

[1] **Inventiveness:** A good designer should have the ability of discovering useful and valuable ideas for processes to obtain given objectives.

[2] **Mathematical Skill:** A good designer should have thorough knowledge of mathematics.

[3] **Engineering Skill:** A good designer should have thorough knowledge of mechanics, mechanisms, structure, engineering materials, manufacturing processes, thermodynamics, fluid mechanics etc.

[4] **Engineering Analysis:** A good designer should have the ability to analyse a system, process or component using principles of science or engineering in order to arrive at meaningful results.

[5] **Decision Making:** A good designer should have the ability of taking decisions quickly during uncertainty with full and balanced grasp of all the factors involved.

[6] **Knowledge of Manufacturing Processes:** A good designer should have the knowledge of both old and new manufacturing processes.

[7] **Communication Skill:** A good designer should have the ability to express himself clearly both in writing and verbal communication.

[8] **Design Skill:** A good designer should have the thorough knowledge of design principles, design procedure and general design considerations.

[9] **Good Judgment:** A good designer should judge all the parameters of design properly and then should apply in the design work.

[10] Ability to Work with People: A good designer should have the ability to work with others in team i.e. he should have co-operative nature.

[11] Knowledge of Standards and Codes: A good designer should have the thorough knowledge of national, international and professional standards and codes. The government rules and regulations cannot be violated and hence a designer should know them in particular.

[12] Engineering Drawing: A good designer should have thorough knowledge of engineering drawing and graphics.

[13] Sense of Responsibility: A good designer should know his/ her responsibilities in all respects.

[14] Energetic: A good designer should be energetic. He should have the ability to work continuously for hours.

[15] Health: A good designer should have good health.

DESIGN TERMINOLOGY

➤ STRESS

When a system of external forces or loads acts on a body, a change in its shape and dimension takes place. To oppose the process of deformation, internal resisting forces are set up in the body due to cohesive forces acting between molecules of material. The resisting forces are uniformly distributed over the entire cross-section. The internal resistance per unit area of cross-section is called stress. The difference between the applied load and stress is that the load is applied externally to the body whereas the stress is induced in the body due to application of load.

If a bar, having uniform cross-section area is acted upon by an external force P , due to cohesion between the molecules, the resistance force is developed in the

body against the deformation. If we consider any section XX' , divided by the area of cross-section (A) is called intensity of stress or stress.

$$\text{i.e., Stress} = \frac{\text{Force or load acting on a body (p)}}{\text{Cross-sectional area of the body (A)}}$$

In S.I. System unit of stress is N/m^2 or N/mm^2 .

In M.K.S. system, the unit of force is kg and the unit of area is m^2 . Therefore the unit of stress in M.K.S system is kgf/m^2 . If the unit of area is cm^2 then unit of stress is kg/cm^2 .

➤ STRAIN:

When an external force or a system of forces is applied on a body, the deformation takes place and there will be change in its dimension. The ratio of this change in the dimensions of the body to the original dimensions is known as strain.

$$\text{Strain } e = \frac{\text{Change in dimensions } (\delta l)}{\text{Original dimensions } (l)}$$

Strain is denoted by e .

It has no unit, because it is the ratio of the same physical quantities. Strain is a measure of the deformation caused due to the original dimensions is known as tensile strain.

➤ FACTOR OF SAFETY

The ratio of ultimate stress and working stress is called factor of safety. It is also known as factor of ignorance.

$$\text{Factor of Safety} = \frac{\text{Ultimate stress}}{\text{Working stress}}$$

➤ FACTORS INFLUENCING MACHINE DESIGN:

The following is a list of factors that influence the machine design process:

1. Load applied
2. Purpose and operating conditions of the part.
3. Suitability for manufacture.

4. Minimum weight and optimal size
5. Availability and cost.

➤ **STRESS CONCENTRATION**

Whenever a machine component changes the shape of its cross section, the simple stress distribution no longer holds good and the neighborhood of the discontinuity is different. This irregularity in the stress distribution caused by abrupt changes of form is called 'stress concentration'.

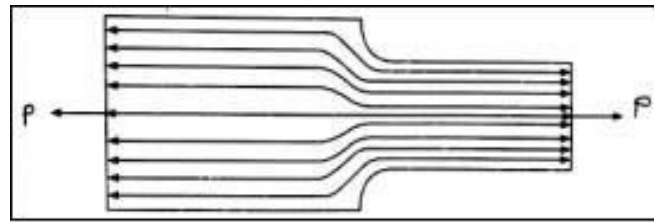

Fig. Stress concentration

Causes of stress concentration The various causes of stress concentration are as follows:

- (i) Abrupt change of cross section
- (ii) Poor surface finish
- (iii) Localized loading
- (iv) Variation in the material properties

➤ **METHODS OF REDUCING STRESS CONCENTRATION**

The presence of stresses concentration cannot be totally eliminated but it can be reduced, so following are the remedial measures to control the effects of stress concentration.

1. Provide additional notches and holes in tension members.
 - a) Use of multiple notches.
 - b) Drilling additional holes.
2. Fillet radius, undercutting and notch for member in bending.
3. Reduction of stress concentration in threaded member.
4. Provide taper cross-section to the sharp corner of member

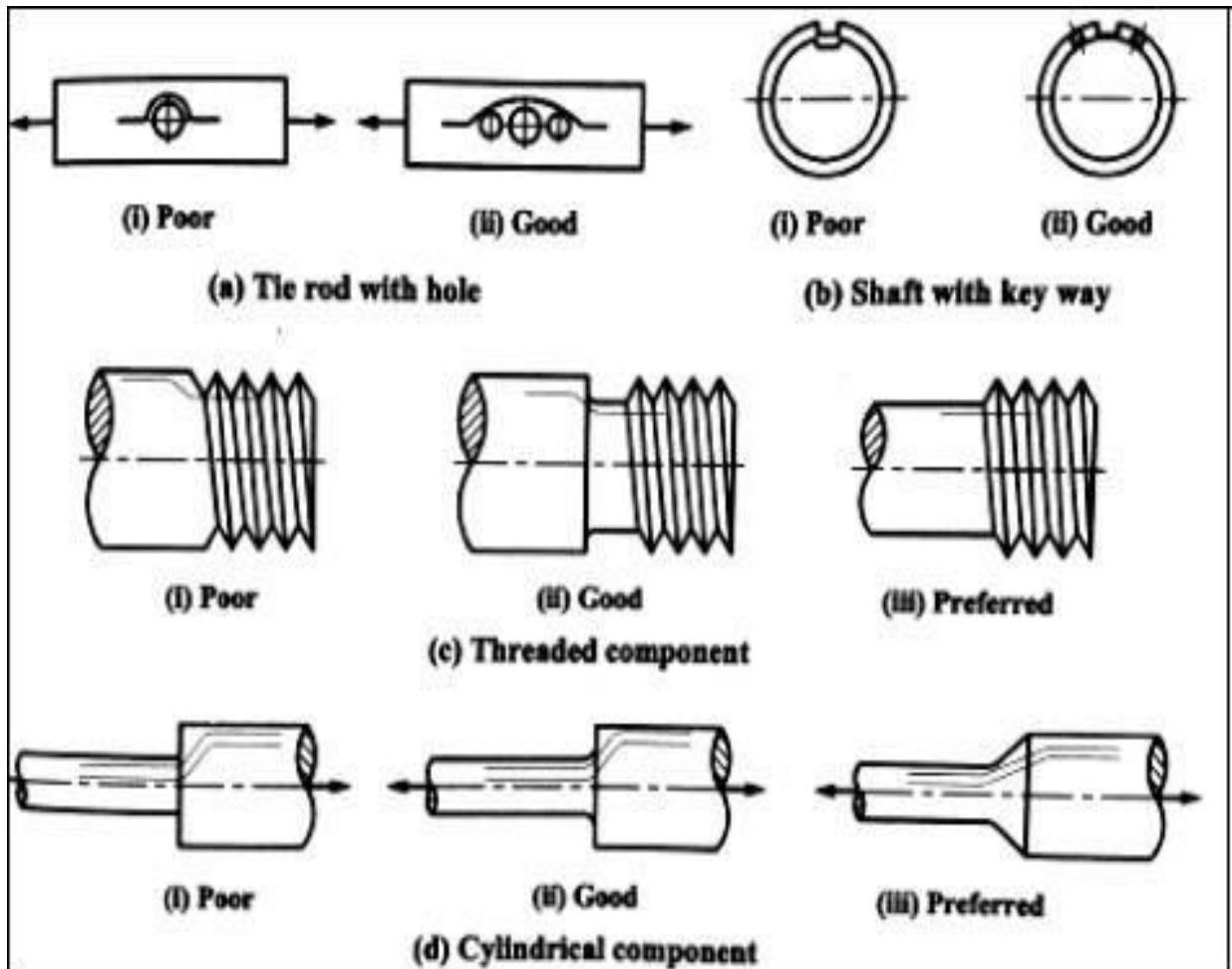

Fig. Methods of reducing stress concentration

➤ **FATIGUE**

When a material is subjected to repeated stresses, it fails at stresses below the yield point stresses. Such type of failure of a material is known as fatigue. The failure is caused by means of a progressive crack formation which are usually fine and of microscopic size. This property is considered in designing shafts, connecting rods, springs, gears, etc.

➤ **ENDURANCE LIMIT**

It is the maximum value of completing reversed stress that can sustain an infinite number (10^6) of cycles without failure.

GENERAL DESIGN CONSIDERATIONS

In this article, we will cover some important factors on which the machine design process is dependant.

1. Type of load and stresses caused by the load.

The load, on a machine component, may act in several ways due to which the internal stresses are set up.

- **Compression-** Applying forces to both ends
- **Tension-** Forces applied in the opposite direction
- **Shear-** Sliding forces that are applied in the opposite direction
- **Bending-** Force off-centered
- **Torsional-** Twisting force
- **Combination** – Combination of any loads

2. Motion of the parts or kinematics of the machine.

The successful operation of any machine depends largely upon the simplest arrangement of the parts which will give the motion required.

The motion of the parts may be:

- (a) Rectilinear motion which includes unidirectional and reciprocating motions.
- (b) Curvilinear motion which includes rotary, oscillatory, and simple harmonic.
- (c) Constant velocity.
- (d) Constant or variable acceleration.

3. Selection of materials

A designer must have a thorough knowledge of the properties of the materials and their behavior under working conditions. Some of the important characteristics of materials are strength, durability, flexibility, weight, resistance to heat and corrosion, ability to cast, welded or hardened, machinability, electrical conductivity, etc.

The selection of a proper material, for engineering purposes, is one of the most difficult problems for the designer. The best material is one which serves the desired objective at the minimum cost. The following factors should be considered while selecting the material:

1. Availability of the materials.
2. Suitability of the materials for the working conditions in service, and
3. The cost of the materials.

The important properties, which determine the utility of the material, are physical, chemical and mechanical properties. We shall now discuss the physical and mechanical properties of the material in the following articles.

4. Form and size of the parts.

The form and size are based on judgment. The smallest practicable cross-section may be used, but it may be checked that the stresses induced in the designed cross-section are reasonably safe. To design any machine part for form and size, it is necessary to know the forces which the part must sustain. It is also important to anticipate any suddenly applied or impact load which may cause failure.

5. Frictional resistance and lubrication.

There is always a loss of power due to frictional resistance and it should be noted that the friction of starting is higher than that of running friction. It is, therefore, essential that careful attention must be given to the matter of lubrication of all surfaces which move in contact with others, whether in rotating, sliding, or rolling bearings.

6. Convenient and economical features.

In designing, the operating features of the machine should be carefully studied. The starting, controlling, and stopping levers should be located based on convenient handling. The adjustment for wear must be provided employing the

various take-up devices and arranging them so that the alignment of parts is preserved. If parts are to be changed for different products or replaced on account of wear or breakage, easy access should be provided and the necessity of removing other parts to accomplish this should be avoided if possible. The economical operation of a machine which is to be used for production or the processing of material should be studied, to learn whether it has the maximum capacity consistent with the production of good work.

7. Use of standard parts.

The use of standard parts is closely related to cost because the cost of standard or stock parts is only a fraction of the cost of similar parts made to order. The standard or stock parts should be used whenever possible; parts for which patterns are already in existence such as gears, pulleys and bearings, and parts that may be selected from regular shop stock such as screws, nuts, and pins. Bolts and studs should be as few as possible to avoid the delay caused by changing drills, reamers, and taps and also to decrease the number of wrenches required.

8. Safety of operation.

Some machines are dangerous to operate, especially those which are speeded up to insure production at a maximum rate. Therefore, any moving part of a machine that is within the zone of a worker is considered an accident hazard and may be the cause of an injury. It is, therefore, necessary that a designer should always provide safety devices for the safety of the operator. The safety appliances should in no way interfere with the operation of the machine.

9. Workshop facilities.

A design engineer should be familiar with the limitations of this employer's workshop, to avoid the necessity of having work done in some other workshop.

It is sometimes necessary to plan and supervise the workshop operations and to draft methods for casting, handling, and machining special parts.

10. The number of machines to be manufactured.

The number of articles or machines to be manufactured affects the design in several ways. The engineering and shop costs which are called fixed charges or overhead expenses are distributed over the number of articles to be manufactured. If only a few articles are to be made, extra expenses are not justified unless the machine is large or of some special design. An order calling for a small number of the product will not permit any undue expense in the workshop processes so that the designer should restrict his specification to standard parts as much as possible.

11. Cost of construction.

The cost of construction of an article is the most important consideration involved in design. In some cases, the high cost of an article may immediately bar it from further considerations. If an article has been invented and tests of handmade samples have shown that it has commercial value, it is then possible to justify the expenditure of a considerable sum of money in the design and development of automatic machines to produce the article, especially if it can be sold in large numbers. The aim of the design engineer under all conditions should be to reduce the manufacturing cost to the minimum.

12. Assembling.

Every machine or structure must be assembled as a unit before it can function. Large units must often be assembled in the shop, tested, and then taken to be transported to their place of service. The final location of any machine is important and the design engineer must anticipate the exact location and the local facilities for erection.

CODES AND STANDARDS (BIS STANDARDS)

A code is set of specifications or procedures laid down for the purpose of analysis, design and manufacture of products.

A standard is a set of specifications or processes intended to obtain uniformity, efficiency and quality.

Standard	Abbreviation
American Society for Mechanical Engineers	ASME
American Society for Testing and Materials	ASTM
American Society for Metals	ASM
American Iron and Steel Institute	AISI
American Gear Manufacturing Association	AGMA
Bureau of Indian Standards	BIS
British Standard Institution	BSI
Society for Automotive Engineers	SAE

ENGINEERING MATERIALS AND THEIR MECHANICAL PROPERTIES

Materials

The knowledge of materials and their properties is of great significance for a design engineer. The machine elements should be made of such a material which has properties suitable for the conditions of operation. In addition to this, a design engineer must be familiar with the effects which the manufacturing processes and heat treatment have on the properties of the materials. Now, we shall discuss the commonly used engineering materials and their properties in Machine Design.

Classification of Engineering Materials

The engineering materials are mainly classified as:

1. Metals and their alloys, such as iron, steel, copper, aluminum, etc.

2. Non-metals, such as glass, rubber, plastic, etc.

The metals may be further classified as:

(a) Ferrous metals and

(b) Non-ferrous metals.

The ferrous metals are those which have the iron as their main constituent, such as cast iron, wrought iron and steel.

The non-ferrous metals are those which have a metal other than iron as their main constituent, such as copper, aluminum, brass, tin, zinc, etc.

MECHANICAL PROPERTIES OF ENGINEERING MATERIALS

The mechanical properties of the metals are those which are associated with the ability of the material to resist mechanical forces and load. These mechanical properties of the metal include strength, stiffness, elasticity, plasticity, ductility, brittleness, malleability, toughness, resilience, creep and hardness.

We shall now discuss these properties as follows:

1. Strength. It is the ability of a material to resist the externally applied forces without breaking or yielding. The internal resistance offered by a part to an externally applied force is called stress.

2. Stiffness. It is the ability of a material to resist deformation under stress. The modulus of elasticity is the measure of stiffness.

3. Elasticity. It is the property of a material to regain its original shape after deformation when the external forces are removed. This property is desirable for materials used in tools and machines. It may be noted that steel is more elastic than rubber.

4. Plasticity. It is property of a material which retains the deformation produced under load permanently. This property of the material is necessary for forgings, in stamping images on coins and in ornamental work.

5. Ductility. It is the property of a material enabling it to be drawn into wire with the application of a tensile force. A ductile material must be both strong and plastic. The ductility is usually measured by the terms, percentage elongation and percentage reduction in area. The ductile material commonly used in engineering practice (in order of diminishing ductility) are mild steel, copper, aluminum, nickel, zinc, tin and lead.

6. Brittleness. It is the property of a material opposite to ductility. It is the property of breaking of a material with little permanent distortion. Brittle materials when subjected to tensile loads snap off without giving any sensible elongation. Cast iron is a brittle material.

7. Malleability. It is a special case of ductility which permits materials to be rolled or hammered into thin sheets. A malleable material should be plastic but it is not essential to be so strong. The malleable materials commonly used in engineering practice (in order of diminishing malleability) are lead, soft steel, wrought iron, copper and aluminum.

8. Toughness. It is the property of a material to resist fracture due to high impact loads like hammer blows. The toughness of the material decreases when it is heated. It is measured by the amount of energy that a unit volume of the material has absorbed after being stressed up to the point of fracture. This property is desirable in parts subjected to shock and impact loads.

9. Machinability. It is the property of a material which refers to a relative ease with which a material can be cut. The machinability of a material can be measured in a number of ways such as comparing the tool life for cutting different materials or thrust required to remove the material at some given rate or the energy required to remove a unit volume of the material. It may be noted that brass can be easily machined than steel.

10. Resilience. It is the property of a material to absorb energy and to resist shock and impact loads. It is measured by the amount of energy absorbed per unit volume within elastic limit. This property is essential for spring materials.

11. Creep. When a part is subjected to a constant stress at high temperature for a long period of time, it will undergo a slow and permanent deformation called creep. This property is considered in designing internal combustion engines, boilers and turbines.

12. Fatigue. When a material is subjected to repeated stresses, it fails at stresses below the yield point stresses. Such type of failure of a material is known as fatigue. The failure is caused by means of a progressive crack formation which are usually fine and of microscopic size. This property is considered in designing shafts, connecting rods, springs, gears, etc.

13. Hardness. It is a very important property of the metals and has a wide variety of meanings. It embraces many different properties such as resistance to wear, scratching, deformation and machinability etc. It also means the ability of a metal to cut another metal.

SELECTION OF MATERIALS, CRITERIA OF MATERIAL SELECTION

- **SELECTION OF MATERIALS**

The selection of a proper material, for engineering purposes, is one of the most difficult problems for the designer. The best material is one which serves the desired objective at the minimum cost.

- **CRITERIA OF MATERIAL SELECTION**

The following criteria should be considered while selecting the material:

1. Availability of the materials,
2. Suitability of the materials for the working conditions in service, and
3. The cost of the materials.
4. Resistance to corrosion
5. Ease of handling and fabrication.
6. Strength

The important properties, which determine the utility of the material, are physical, chemical and mechanical properties. We shall now discuss the physical and mechanical properties of the material in the following articles.

CHAPTER-2

DESIGN FAILURE

INTRODUCTION

Theories of failure are employed in the design of a machine component due to the unavailability of failure stresses under combined loading conditions.

Theories of failure play a key role in establishing the relationship between stresses induced under combined loading conditions and properties obtained from tension test like **ultimate tensile strength (S_{ut})** and **yield strength (S_{yt})**.

Stresses induced under combined loading conditions and (S_{yt} and S_{ut}) obtained using tension test which are called **theories of failure**

VARIOUS DESIGN FAILURE

Various theories of design failure are as below:

1. Maximum Principal Stress theory also known as RANKINE'S THEORY
2. Maximum Shear Stress theory or GUEST AND TRESCA'S THEORY
3. Maximum Principal Strain theory also known as St. VENANT'S THEORY
4. Total Strain Energy theory or HAIGH'S THEORY

1. Maximum Principal Stress theory (M.P.S.T)

According to M.P.S. T, Condition for failure is,

Maximum principal stress (σ_1) > failure stresses (S_{yt} or S_{ut})

and Factor of safety (F.O.S) = 1

If σ_1 is +ve then S_{yt} or S_{ut}

σ_1 is -ve then S_{yc} or S_{uc}

Condition for safe design,

Factor of safety (F.O.S) > 1

Maximum principal stress (σ_1) \leq Permissible stress (σ_{per})

Where permissible stress = Failure stress/Factor of safety = S_{yt}/N or S_{ut}/N

$\sigma_1 \leq S_{yt}/N$ or S_{ut}/NEqn (1)

Note:

1. This theory is suitable for the safe design of machine components made of brittle materials under all loading conditions (tri-axial, biaxial etc.) because brittle materials are weak in tension.
2. This theory is not suitable for the safe design of machine components made of ductile materials because ductile materials are weak in shear.
3. This theory can be suitable for the safe design of machine components made of ductile materials under following state of stress conditions.

(i) Uniaxial state of stress (Absolute $\tau_{max} = \sigma_1/2$)

(ii) Biaxial state of stress when principal stresses are like in nature

(Absolute $\tau_{max} = \sigma_1/2$)

(iii) Under hydrostatic stress condition (shear stress in all the planes is zero).

2. Maximum Shear Stress theory (M.S.S.T)

Condition for failure,

Maximum shear stress induced at a critical point under triaxial combined stress

>Yield strength in shear under tensile test

Absolute $\tau_{max} > (S_{ys})T.T$ or $S_{yt}/2$

unknown therefore use S_{yt}

Condition for safe design,

Maximum shear stress induced at a critical tensile point under tri-axial

combined stress \leq Permissible shear stress (τ_{per})

Note:

1. M.S.S.T and M.P.S.T will give same results for ductile materials under uniaxial state of stress and biaxial state of stress when principal stresses are like in nature.
2. M.S.S.T is not suitable under hydrostatic stress condition.
3. This theory is suitable for ductile materials and gives oversafe design i.e. safe and uneconomic design.

3. Maximum Principal Strain theory (M.P.St.T)

Condition for failure,

Maximum Principal Strain (ϵ_1) > Yielding strain under tensile test ($\epsilon_{Y.P.}$)_{T.T}

$$\epsilon_1 > (\epsilon_{Y.P.})_{T.T} \text{ or } S_{yt}/E$$

where E is Young's Modulus of Elasticity

Condition for safe design,

Maximum Principal Strain \leq Permissible strain

Where Permissible strain = Yielding strain under tensile test / Factor of safety =

$$(\epsilon_{Y.P.})_{T.T} / N = S_{yt} / EN$$

$$\epsilon_1 \leq S_{yt} / EN$$

$$1/E [\sigma_1 - \mu(\sigma_2 + \sigma_3)] \leq S_{yt} / EN$$

4. Total Strain Energy theory (T.St.E.T)

Condition for failure,

Total Strain Energy per unit volume (T.S.E. /vol.) > Strain energy per unit volume at yield point under tension test (S.E /vol.)_{Y.P.}]_{T.T}}

Condition for safe design,

Total Strain Energy per unit volume \leq Strain energy per unit volume at yield point

Under tension test

$$\text{Total Strain Energy per unit volume} = 1/2 \sigma_1 \epsilon_1 + 1/2 \sigma_2 \epsilon_2 + 1/2 \sigma_3 \epsilon_3$$

Note: Total strain energy theory is suitable under hydrostatic stress condition.

CLASSIFICATION OF LOADS

A load may be defined as the combined effect of external forces acting on a body.

The loads may be classified as

- **Dead Load:** It is refer to loads that typically don't change over time, such as the weights of materials and components of the structure itself (the framing, the flooring material, roofing material, etc.),and the weights of fixed service equipment (plumbing, HVAC, etc.).

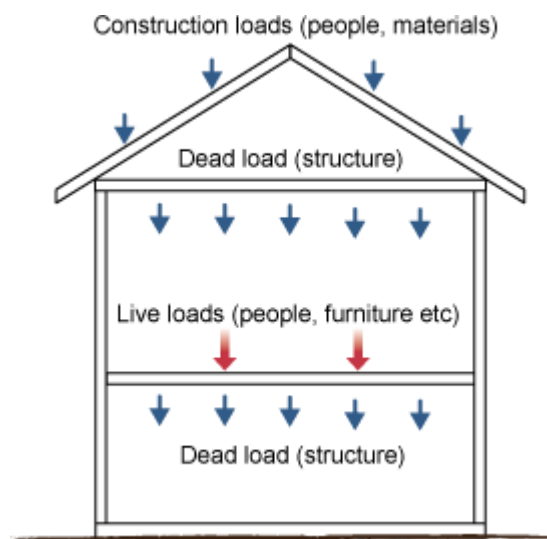

- **Live or Fluctuating Load:** It is refer to loads that do, or can, change over time, such as people walking around a building (occupancy) or movable objects such as a flower pot on a deck. In addition to live loads, what is known as environmental loads are loads that are created naturally by the environment and include wind, snow, seismic, and lateral soil pressures.

The other way Load may be classified as

- **Tensile Load:** This component measures the pulling action perpendicular to the section. A pulling action represents a tensile force that tends to elongate the member.

- **Compressive Load:** This component measures the pushing action perpendicular to the section. A pushing action represents a compressive force that tends to shorten the member.

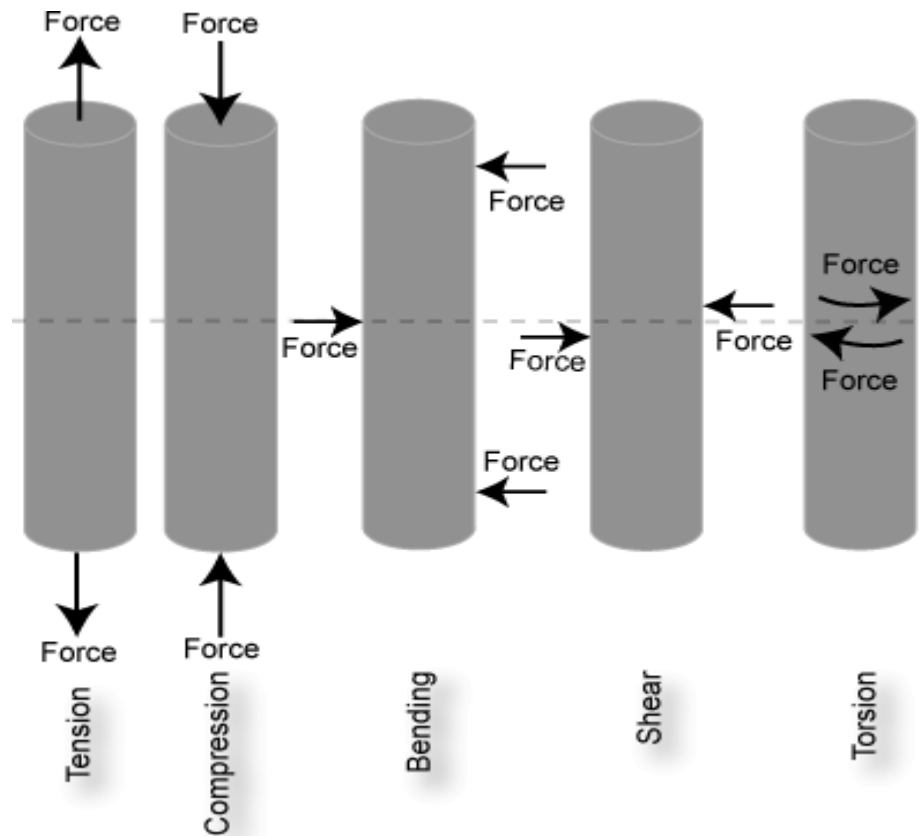

- **Shearing Load:** Shear involves applying a load parallel to a plane which caused the material on one side of the plane to want to slide across the material on the other side of the plane.
- **Bending Load:** Bending involves applying a load in a manner that causes a material to curve and results in compressing the material on one side and stretching it on the other.
- **Torsional Load:** Torsion is the application of a force that causes twisting in a material.

Load may also be classified as

- **Point or Concentrated Load:** A load acting at a point of a beam is known as point or concentrated load.

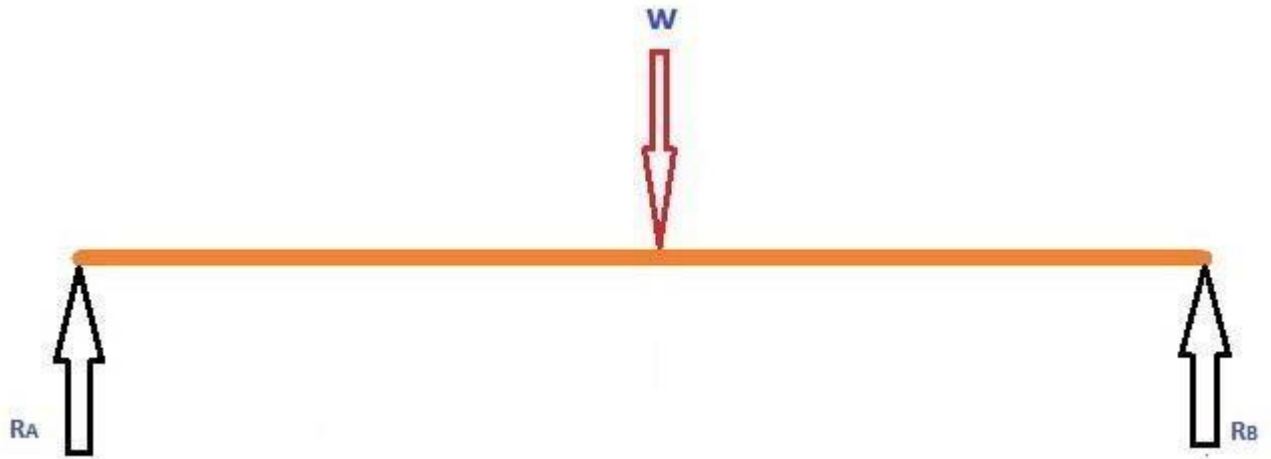

- **Uniformly Distributed Load:** A load which is spread over a beam in such a way that each unit length is loaded to the same extent, is known as uniformly distributed load.

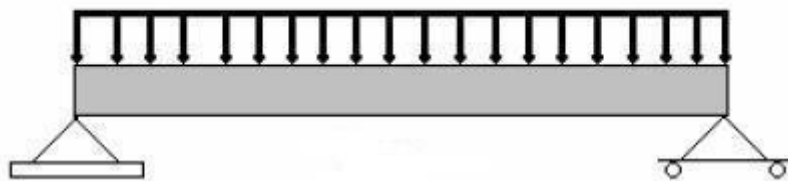

- **Uniformly Varying Load:** A load which is spread over a beam in such a way that it varies uniformly on each unit length, is known as uniformly varying load. Sometimes, the load is zero at one end and increases uniformly to the other. Such a load is known as **Triangular Load**.

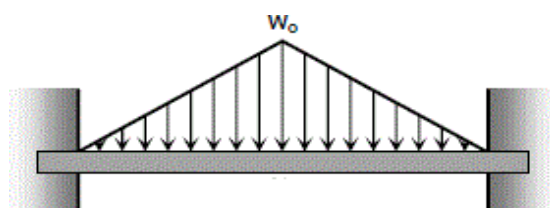
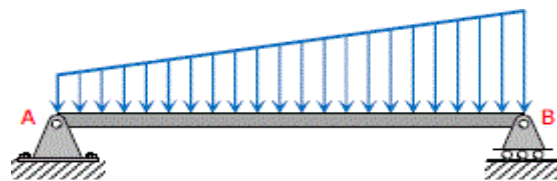

DESIGN UNDER TENSILE, COMPRESSIVE AND TORSIONAL STRESS

- **Tensile stress**

The stress developed in the bar subjected to tensile loading is given by

$$\sigma_t = P/A.$$

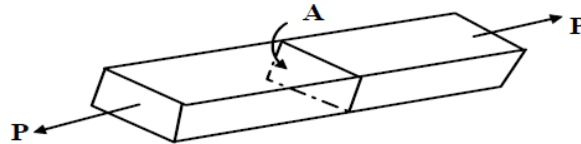

- **Compressive stress**

The stress developed in the bar subjected to compressive loading is given by

$$\sigma_c = P/A.$$

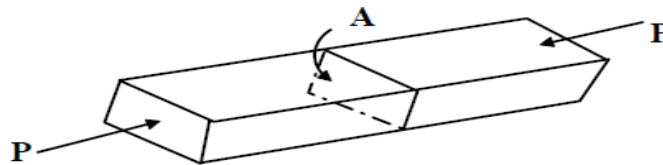

Here the force P is the resultant force acting normal to the cross-section A . However, if we consider the stresses on an inclined cross-section B then the normal stress perpendicular to the section is

$$\sigma_\theta = \frac{P \cos \theta}{A / \cos \theta}$$

and shear stress parallel to the section

$$\tau = P \sin \theta / (A / \cos \theta)$$

- **Torsion of circular members**

A torque applied to a member causes shear stress. In order to establish a relation between the torque and shear stress developed in a circular member, the following assumptions are needed:

1. Material is homogeneous and isotropic

2. A plane section perpendicular to the axis of the circular member remains plane even after twisting i.e. no warping.

3. Materials obey Hooke's law.

Therefore for any radius r we may write in general= τ

We have thus the general torsion equation for circular shafts as

$$\frac{T}{J} = \frac{\tau}{r} = \frac{G\theta}{l}$$

CHAPTER-3

DESIGN OF SHAFT

INTRODUCTION

Shaft is a rotating element, usually of circular cross-section, which we use to transmit power or motion.

TYPE OF SHAFTS, SHAFT MATERIALS, TYPES OF LOADING ON SHAFT & STANDARD SIZES OF SHAFT AVAILABLE

➤ **TYPE OF SHAFTS**

There are two types of shafts

1. Machine Shafts
2. Power Transmission Shafts

Machine shaft

Machine shaft is integral part of the machine itself. E.g. crank shaft.

Power transmission shafts

These shafts are used for power transmissions. E.g. line shaft, jack shaft, counter shaft

➤ **SHAFT MATERIALS**

The material used for ordinary shafts is mild steel. When high strength is required, an alloy steel such as

1. nickel steel
2. nickel-chromium steel or
3. chromium-vanadium steel is used.

➤ **TYPES OF LOADING ON SHAFT**

The type of loading on the shafts may be as under:

- Shafts subjected to twisting moment only.
- Shafts subjected to bending moment only.
- Shafts subjected to combined twisting moment and bending moment.
- Shafts subjected to axial load in addition to twisting and bending moment.

➤ **STANDARD SIZES OF SHAFT AVAILABLE**

- Standard length of shafts is from 5m, 6m, and 7m.
- Diameters
 - 25 mm to 60 mm with 5 mm steps
 - 60 mm to 110 mm with 10 mm steps
 - 110 mm to 140 mm with 15 mm steps
 - 140 mm to 500 mm with 20 mm steps

**SHAFT SUBJECTED TO TORSION ONLY,
DETERMINATION OF SHAFT DIAMETER (HOLLOW AND
SOLID SHAFT) ON THE BASIS OF:**

- **STRENGTH CRITERION**
- **RIGIDITY CRITERION**

- **SHAFT SUBJECTED TO TORSION ONLY**

For a shaft subjected twisting moment, the angle of twist is given by,

$$\theta = \frac{TL}{GJ} \leq [\theta]$$

Where, T = Torque applied

L = Length of the shaft

J = Polar moment of inertia of the shaft about the axis of rotation

G = Modulus of rigidity of the shaft material

Therefore for the known values of T, L and G and allowable value of angle of twist, **diameter of the shaft can be calculated.**

- **DETERMINATION OF SHAFT DIAMETER (HOLLOW AND SOLID SHAFT) IN THE BASIS OF:**
 - ✓ **STRENGTH CRITERION**
 - ✓ **RIGIDITY CRITERION**

ON THE BASIS OF STRENGTH CRITERION

In designing shafts on the basis of strength, the following cases must be considered:

- Shafts are subjected to twisting moment and torque only.
 - Shafts are subjected to bending moment only.
 - Shafts are subjected to combined twisting and bending moments, and
- **Shafts are subjected to twisting moment and torque only**

Maximum shear stress developed in a shaft subjected to torque is given by,

shaft,
$$\tau = \frac{T r}{J} \leq [\tau]$$

where T = Twisting moment (or torque) acting upon the

J = Polar moment of inertia of the shaft about the axis of rotation

$$= \frac{\pi d^4}{32} \quad \text{for solid shafts with diameter } d$$

$$= \frac{\pi (d_o^4 - d_i^4)}{32} \quad \text{for hollow shafts with } d_o \text{ and } d_i \text{ as outer and inner diameter.}$$

r = Distance from neutral axis to the outer most fibre = d/2
(or $d_o/2$)

So dimensions of the shaft subjected to torque can be determined from above relation for a known value of allowable shear stress, $[\tau]$.

Data:- $P = 550 \text{ kW}$

$N = 115 \text{ RPM}$

$\tau = 78 \text{ MPa}$

$d_i = 0.75 d_o$

→ For solid shaft

$$\frac{T}{J_p} = \frac{\tau}{r}$$

But $P = \frac{2\pi NT}{60}$ (W)

$$\therefore 550 \times 10^3 = \frac{2 \times \pi \times 115 \times T}{60} \quad (\text{W})$$

$$\therefore T = 45670.54 \text{ Nm}$$

$$T = 45670.54 \times 10^3 \text{ Nmm}$$

$$\text{Now, } \frac{4576 \times 45670.54 \times 10^3}{\frac{\pi \times d^4}{32}} = 78 \quad \left(\frac{d}{2}\right)$$

$$\therefore d = 143.93 \text{ mm}$$

Now, For Hollow Shaft :-

$$\frac{T}{J_p} = \frac{\tau}{r}$$

$$\therefore \frac{45670.54 \times 10^3}{\frac{\pi (d_o^4 - d_i^4)}{32}} = 78 \quad d_o$$

$$\frac{45670.54 \times 10^3}{\frac{\pi \times (d_o^4 - 0.75^4 d_o^4)}{32}} = 78 \quad \left(\frac{d_o}{2}\right)$$

$$\therefore d_o = 163.30 \text{ mm}$$

$$\& d_i = 0.75 \times d_o = \frac{340.27 \text{ mm}}{122.54 \text{ mm}}$$

- **Shaft subjected to Bending Moment**

Maximum bending stress developed in a shaft is given by,

$$\sigma_b = \frac{M y}{I} \leq [\sigma_t]$$

Where M = Bending Moment acting upon the shaft,

I = Moment of inertia of cross-sectional area of the shaft about the axis of rotation

$$= \frac{\pi d^4}{64} \quad \text{for solid shafts with diameter } d$$

$$= \frac{\pi(d_o^4 - d_i^4)}{64}$$
 for hollow shafts with d_o and d_i as outer and inner diameter.

$y =$ Distance from neutral axis to the outer most fibre $= d / 2$ (or $d_o/2$)

So dimensions of the shaft subjected to bending moment can be determined from above relation for a known value of allowable tensile stress.

- **Shaft diameter subjected to combination torsion and bending**

When the shaft is subjected to combination of torque and bending moment, principal stresses are calculated and then following different theories of failure are used. Bending stress and torsional shear stress can be calculated using the above relations.

$$\tau = \frac{T r}{J} = \frac{T \frac{d}{2}}{\frac{\pi}{32} d^4} = \frac{16 T}{\pi d^3}$$

$$\sigma_b = \frac{M y}{I} = \frac{M \frac{d}{2}}{\frac{\pi}{64} d^4} = \frac{32 M}{\pi d^3}$$

Maximum Shear Stress Theory

Maximum shear stress is given by,

$$\tau_{max.} = \sqrt{\left(\frac{\sigma_b}{2}\right)^2 + (\tau)^2} = \sqrt{\left(\frac{16 M}{\pi d^3}\right)^2 + \left(\frac{16 T}{\pi d^3}\right)^2} = \frac{16}{\pi d^3} \sqrt{M^2 + T^2} \leq [\tau]$$

$\sqrt{M^2 + T^2}$ is called equivalent torque, T_e , such that

$$\tau_{max.} = \frac{T_e r}{J} \leq [\tau]$$

Maximum Principal Stress Theory

Maximum principal stress is given by,

$$\sigma = \frac{\sigma_b}{2} + \sqrt{\left(\frac{\sigma_b}{2}\right)^2 + (\tau)^2} = \frac{16 M}{\pi d^3} + \sqrt{\left(\frac{16 M}{\pi d^3}\right)^2 + \left(\frac{16 T}{\pi d^3}\right)^2} = \frac{16}{\pi d^3} [M + \sqrt{M^2 + T^2}] \leq [\sigma_t]$$

$[M + \sqrt{M^2 + T^2}]$ is called equivalent bending moment, M_e , such that

$$\sigma = \frac{M_e y}{I} \leq [\sigma_t]$$

- **DETERMINATION OF SHAFT DIAMETER (HOLLOW AND SOLID SHAFT) IN THE BASIS OF RIGIDITY CRITERION**

The torsion equation is

$$\frac{T}{J} = \frac{G\theta}{L}$$

Where θ = Angle of twist

T = Torque

L = Length of shaft

G = Modulus of Rigidity

J = Polar Moment of Inertia of cross-section of shaft about the axis of rotation

In case of solid shaft

$$J = \frac{\pi d^4}{32}$$

Here d is Diameter of shaft

In case of Hollow Shaft

$$J = \frac{\pi}{32} [(d_o)^4 - (d_i)^4]$$

Where d_o is Outer diameter and d_i is Inner diameter.

So diameter of the shaft subjected to bending moment can be determined from above relation for a known value of above relations.

DETERMINATION OF SHAFT DIAMETER SUBJECTED TO BENDING

Maximum bending stress developed in a shaft is given by,

$$\sigma_b = \frac{M y}{I} \leq [\sigma_t]$$

Where M = Bending Moment acting upon the shaft,

I = Moment of inertia of cross-sectional area of the shaft about the axis of rotation

$$= \frac{\pi d^4}{64} \quad \text{for solid shafts with diameter } d$$

$$= \frac{\pi (d_o^4 - d_i^4)}{64} \quad \text{for hollow shafts with } d_o \text{ and } d_i \text{ as outer and inner diameter.}$$

y = Distance from neutral axis to the outer most fibre = $d / 2$ (or $d_o / 2$)

So dimensions of the shaft subjected to bending moment can be determined from above relation for a known value of allowable tensile stress.

DETERMINATION OF SHAFT DIAMETER SUBJECTED TO COMBINATION TORSION AND BENDING

When the shaft is subjected to combination of torque and bending moment, principal stresses are calculated and then different theories of failure are used. Bending stress and torsional shear stress can be calculated using the above relations.

$$\tau = \frac{T r}{J} = \frac{T \frac{d}{2}}{\frac{\pi}{32} d^4} = \frac{16 T}{\pi d^3}$$

$$\sigma_b = \frac{M y}{I} = \frac{M \frac{d}{2}}{\frac{\pi}{64} d^4} = \frac{32 M}{\pi d^3}$$

Maximum Shear Stress Theory

Maximum shear stress is given by,

$$\tau_{max.} = \sqrt{\left(\frac{\sigma_b}{2}\right)^2 + (\tau)^2} = \sqrt{\left(\frac{16 M}{\pi d^3}\right)^2 + \left(\frac{16 T}{\pi d^3}\right)^2} = \frac{16}{\pi d^3} \sqrt{M^2 + T^2} \leq [\tau]$$

$\sqrt{M^2 + T^2}$ is called equivalent torque, T_e , such that

$$\tau_{max.} = \frac{T_e r}{J} \leq [\tau]$$

Maximum Principal Stress Theory

Maximum principal stress is given by,

$$\sigma = \frac{\sigma_b}{2} + \sqrt{\left(\frac{\sigma_b}{2}\right)^2 + (\tau)^2} = \frac{16 M}{\pi d^3} + \sqrt{\left(\frac{16 M}{\pi d^3}\right)^2 + \left(\frac{16 T}{\pi d^3}\right)^2} = \frac{16}{\pi d^3} [M + \sqrt{M^2 + T^2}] \leq [\sigma_t]$$

$[M + \sqrt{M^2 + T^2}]$ is called equivalent bending moment, M_e , such that

$$\sigma = \frac{M_e y}{I} \leq [\sigma_t]$$

CHAPTER-4

DESIGN OF KEY

Introduction

Key is a machine element which is used to connect the transmission shaft to rotating machine elements like pulley, gear, sprocket or flywheel. Keys provide a positive means of transmitting torque between shaft and hub of the mating element. A slot is machined in the shaft or in the hub or both to accommodate the key is called keyway. Keyway reduces the strength of the shaft as it results in stress concentration.

TYPES OF KEY, MATERIAL OF KEY, FUNCTION OF KEY

➤ TYPES OF KEY

Common types of keys are:

1. Sunk keys
2. Saddle keys

Sunk keys

A sunk key is a key in which half of the thickness of key fits into the keyway in the shaft and half in the keyway of the hub. The sunk keys are of the following types:

Rectangular sunk key: It is the simplest type of key and has a rectangular cross-section. A taper of about 1 in 100 is provided on its top side. Rectangular sunk key is shown in Figure.

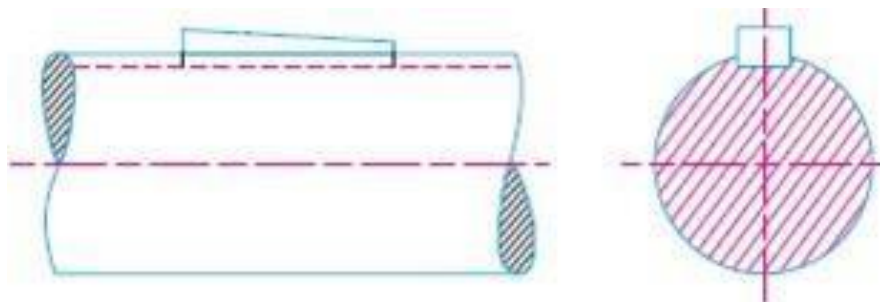

Fig. Rectangular Sunk Key

Square sunk key: Rectangular sunk key having equal width and thickness is called square sunk key.

Parallel sunk key: If no taper is provided on the rectangular or square sunk key, it is called parallel sunk key i.e. it is uniform in width and thickness throughout. It is used where the pulley, gear or other mating piece is required to slide along the shaft.

Gib-head key: It is a rectangular sunk key with a head at one end known as gib head, which is provided to facilitate the removal of key. Gib Head key is shown in Figure.

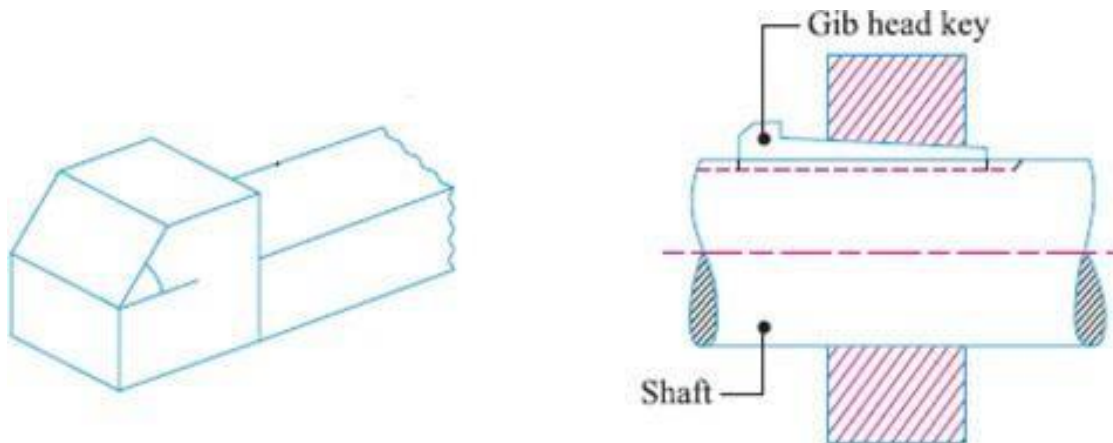

Fig. Gib Head Key

Feather key: Feather key is a parallel key made as an integral part of the shaft with the help of machining or using set-screws. It permits axial movement and has a sliding fit in the key way of the moving piece. Feather keys are shown in Figure 15.3.

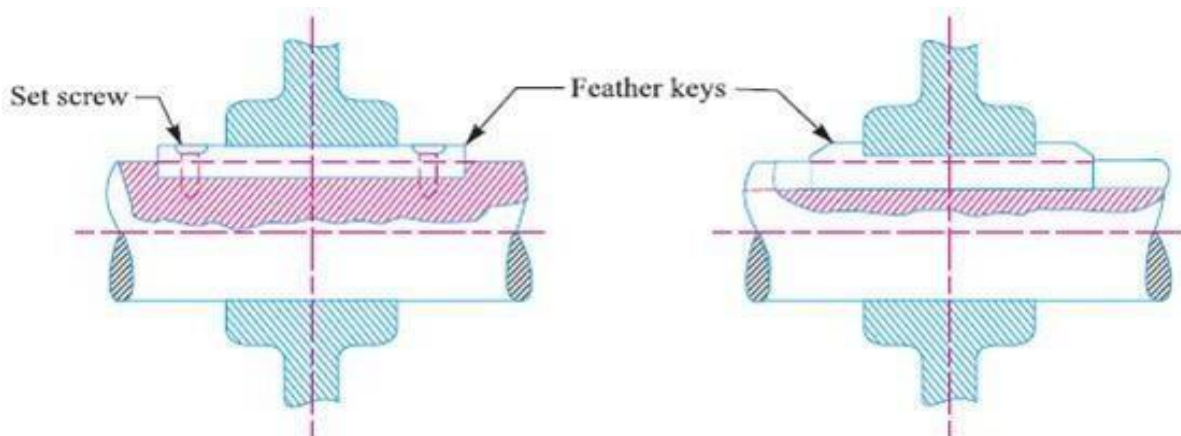

Fig. Feather Key

Woodruff key: Woodruff key is a sunk key in the form of a semicircular disc of uniform thickness. Lower portion of the key fits into the circular keyway of the shaft. It can be used with tapered shafts as it can tilt and

align itself on the shaft. But the extra depth of keyway in the shaft increases stress concentration and reduces strength of the shaft. Woodruff key is shown in Figure.

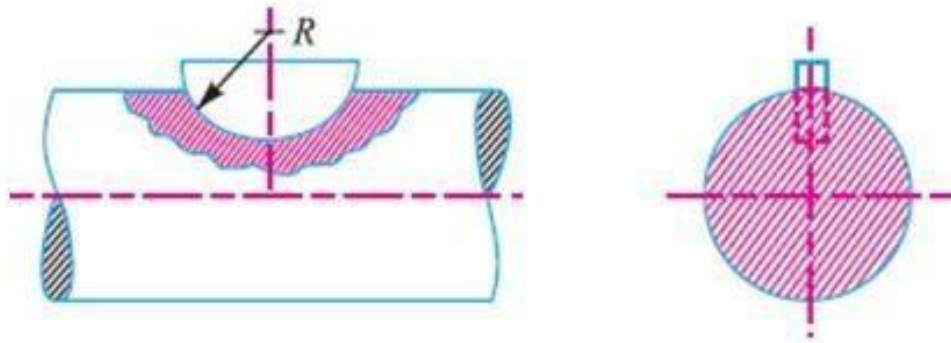

Fig. Woodruff Key

Round Keys: The round keys have a circular cross-section and fit into holes drilled partly in the shaft and partly in the hub. Slot is drilled after the assembly so the shafts can be properly aligned. These are used for low torque transmission. Round keys are shown in Figure .

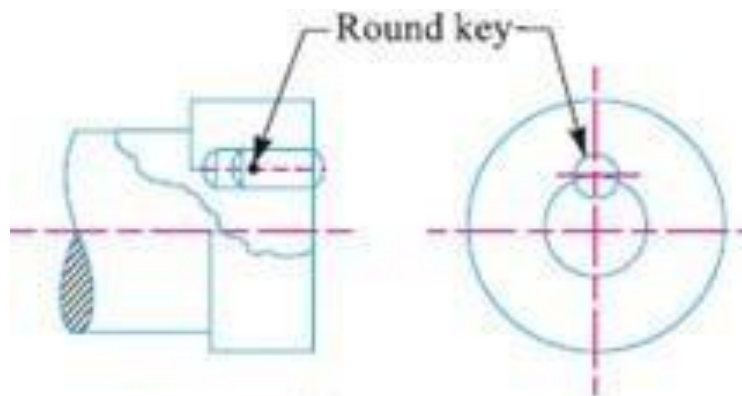

Fig. Round Key

Saddle Keys

A saddle key is simply mounted on the shaft and inserted in the keyway provided in hub and no keyway is provided in shaft. These keys are used for light loads

Types of Saddle Key

1. Flat saddle key
2. Hollow saddle key

➤ **MATERIAL OF KEY**

Mild steel is used for key.

➤ FUNCTION OF KEY

It is used in the shaft to transmit the motion from one shaft to another

FAILURE OF KEY (by Shearing and Crushing)

- Shear Failure
- Crushing Failure

In the design of key two types of failures are considered, shear failure and crushing failure.

Area resisting shear failure = $w l$

Shear stress, $\tau = \frac{P}{bl} \leq [\tau]$

Crushing Area = $l h/2$

Crushing stress, $\sigma_{crushing} = \frac{P}{l h/2} \leq [\sigma_c]$

DESIGN OF KEY (Determination of key dimension)

➤ DESIGN OF SUNK KEYS

Figure shows the forces acting on a rectangular key having width w and height h . Let l be the length of the key. Torque is transmitted from the shaft to the hub through key. Shaft applies a force P on the key and the key applies an equal force on the hub. Therefore the key is acted upon by two equal forces of magnitude P , one applied by the shaft (on the lower portion) and the other because of the reaction of hub (on the upper portion).

As these two forces are not in same plane, they constitute a couple which tries to tilt the key. Therefore equal and opposite forces P' also act on the key, which provide a resisting couple that keeps the key in position.

As the exact location of force P is not known, to simplify the analysis it is assumed that the force P acts tangential to the shaft. If T is the torque transmitted,

$$P = \frac{T}{d/2}$$

Where, d = diameter of the shaft

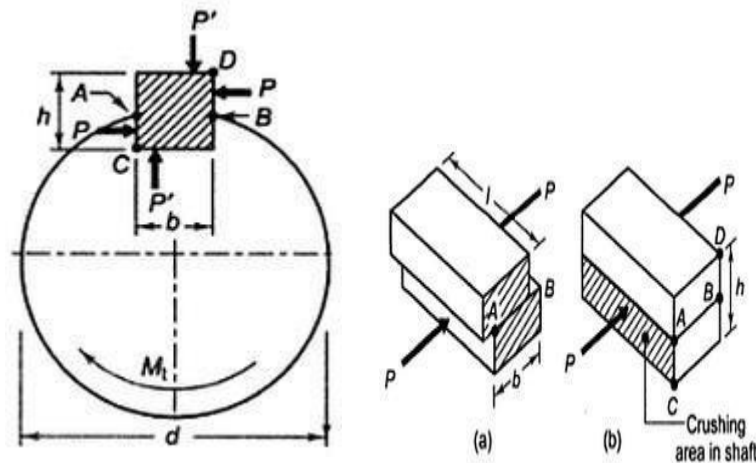

Fig. Forces Acting on Key

As we know Failure of Key

- a. Shear Failure
- b. Crushing Failure as shown in fig

In the design of key two types of failures are considered, shear failure and crushing failure.

Area resisting shear failure = $w l$

Shear stress,
$$\tau = \frac{P}{bl} \leq [\tau]$$

Crushing Area = $l h/2$

Crushing stress,
$$\sigma_{crushing} = \frac{P}{l h/2} \leq [\sigma_c]$$

Tables are available which give standard cross-sections for square and rectangular keys corresponding to different shaft diameters. But in the absence of such data, following relations are generally used:

For Rectangular Key: $w = d / 4$ and $h = d / 6$

For Square Key: $w = h = d / 4$

For a known diameter of shaft, w and h can be calculated using these relations and then using the above strength equations required length of the key is calculated for given values of allowable stresses. Length is calculated both for shear and crushing and then maximum value out of the two is considered.

EFFECT OF KEYWAY ON SHAFT STRENGTH

Little consideration will show that the keyway cut into the shaft reduces the load carrying capacity of the shaft. This is due to the stress concentration near the corners of the keyway and reduction in the cross-sectional area of the shaft.

In other words, the torsional strength of the shaft is reduced. The following relation for the weakening effect of the keyway is based on the experimental results by H.F. Moore.

$$e = 1 - 0.2 \left(\frac{w}{d} \right) - 1.1 \left(\frac{h}{d} \right)$$

where e = Shaft strength factor.

w = Width of keyway,

d = Diameter of shaft, and

h = Depth of keyway = Thickness of key (t)/2

It is usually assumed that the strength of the keyed shaft is 75% of the solid shaft, which is somewhat higher than the value obtained by the above relation.

In case the keyway is too long and the key is of sliding type, then the angle of twist is increased in the ratio K_{θ} as given by the following relation

$$K_{\theta} = 1 + 0.4 \left(\frac{w}{d} \right) - 0.7 \left(\frac{h}{d} \right)$$

where k_{θ} = Reduction factor for angular twist.